

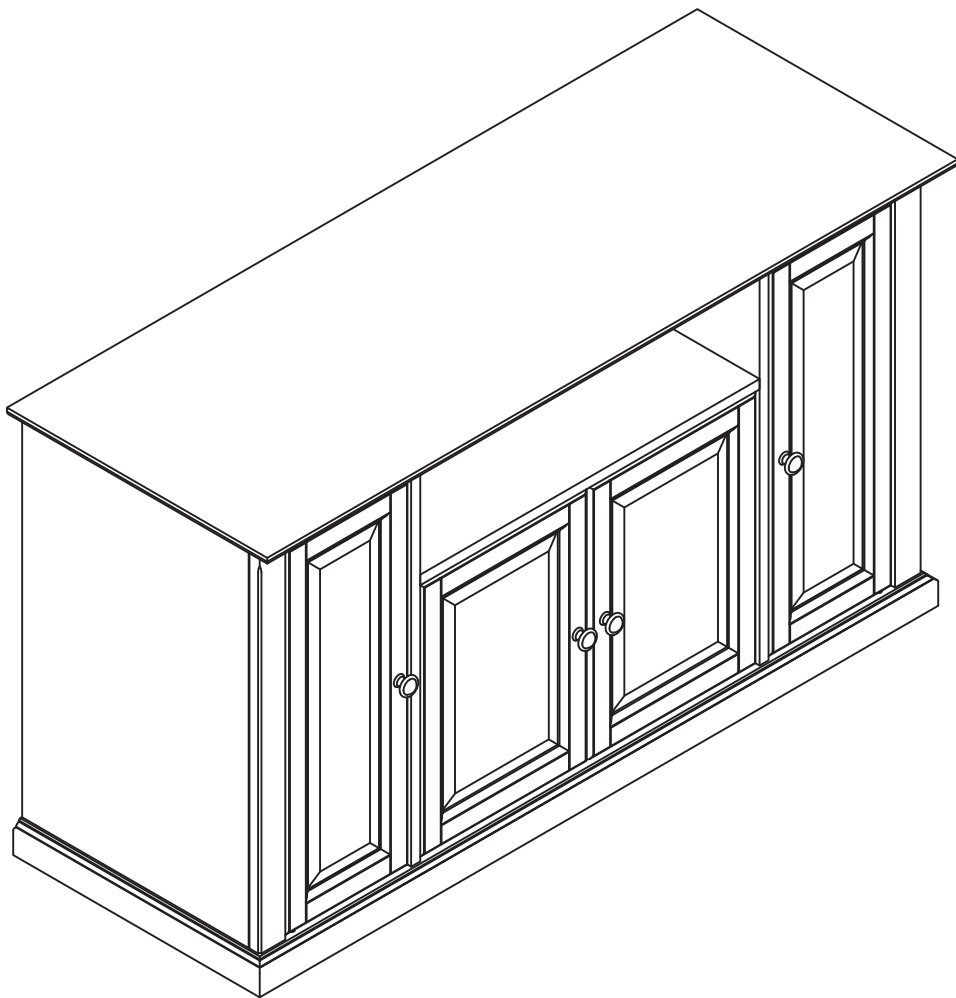

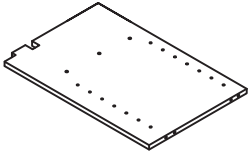

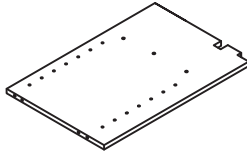

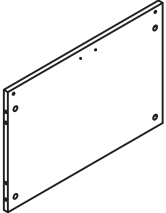

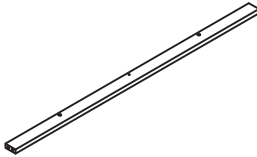
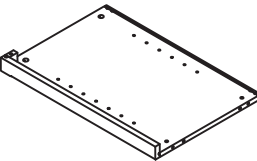
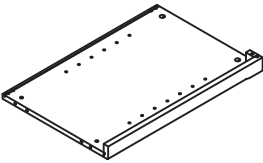

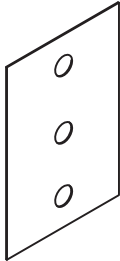

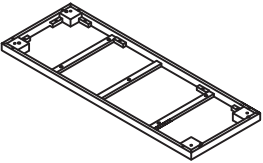
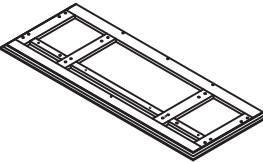
48" TV Stand
CF100148

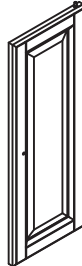
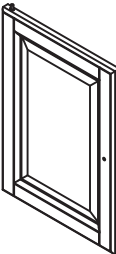
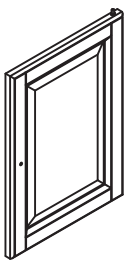
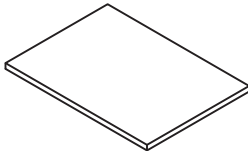
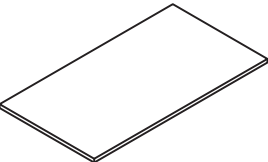
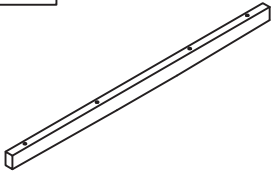

PART LIST

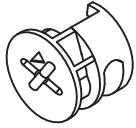
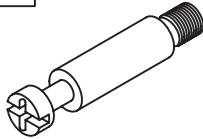
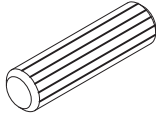
<p>A</p> 	<p>B</p> 	<p>C</p> 	<p>D</p> 	<p>E</p> 
<p>Left Vertical Panel 1 PC</p>	<p>Right Vertical Panel 1 PC</p>	<p>Fixed Shelf 1 PC</p>	<p>Front Top Rail 1 PC</p>	<p>Left Panel 1 PC</p>
<p>F</p> 	<p>G</p> 	<p>H</p> 	<p>I</p> 	<p>J</p> 
<p>Right Panel 1 PC</p>	<p>Back Rail 2 PCS</p>	<p>Back Panel 2 PCS</p>	<p>Middle Back Panel 1 PC</p>	<p>Back Horizontal Rail 2 PCS</p>
<p>K</p> 	<p>L</p> 	<p>M</p> 	<p>N</p> 	<p>O</p> 
<p>Bottom Panel 1 PC</p>	<p>Top Panel 1 PC</p>	<p>Left Door Panel 1 PC</p>	<p>Right Door Panel 1 PC</p>	<p>Left Middle Door Panel 1 PC</p>
<p>P</p> 	<p>Q</p> 	<p>R</p> 	<p>S</p> 	
<p>Right Middle Door Panel 1 PC</p>	<p>Adjustable Shelf 4 PCS</p>	<p>Middle Adjustable Shelf 1 PC</p>	<p>Support Rail 1 PC</p>	

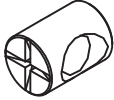
HARDWARE LIST

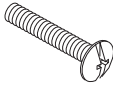
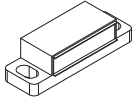
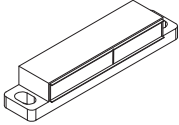
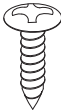
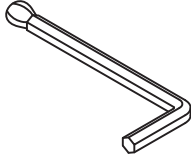
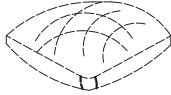
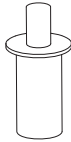
#1 	#2 	#3 	#4 	#5 
Cam Lock 20 PCS (Extra 2)	Cam Bolt 20 PCS	Wood Dowel 42 PCS	Screw 7 PCS (Extra 1)	Hex Socket Head Bolt 8 PCS
#6 	#7 	#8 	#9 	#10 
Barrel Nut 8 PCS	Shelf Holder 20 PCS	Knob 4 PCS	Round Head Bolt 4 PCS	Magnet 2 PCS
#11 	#12 	#13 	#14 	 (Spare Part)
Double Magnet 1 PC	Round Head Screw 6 PCS (Extra 1)	Allen Wrench 1 PC	Safety Strap Kit 1 SET	Pin Hinge (Extra 4)

ADDITIONAL TOOLS (Not Provided)

Note: It is not recommended to use power tools during assembly.



Phillips Head Screwdriver

Note: Wood dowels are intended for alignment. Additional clearance between wood dowel and pre-drilled hole is intentional for ease of assembly.

Step 1. Insert cam bolts (part #2) into left vertical panel (part A), right vertical panel (part B), left panel (part E), right panel (part F), bottom panel (part K) and top panel (part L) using phillips head screwdriver.

NOTE: Do not overtighten cam bolts. Stop tightening once threads on cam bolt are no longer visible.

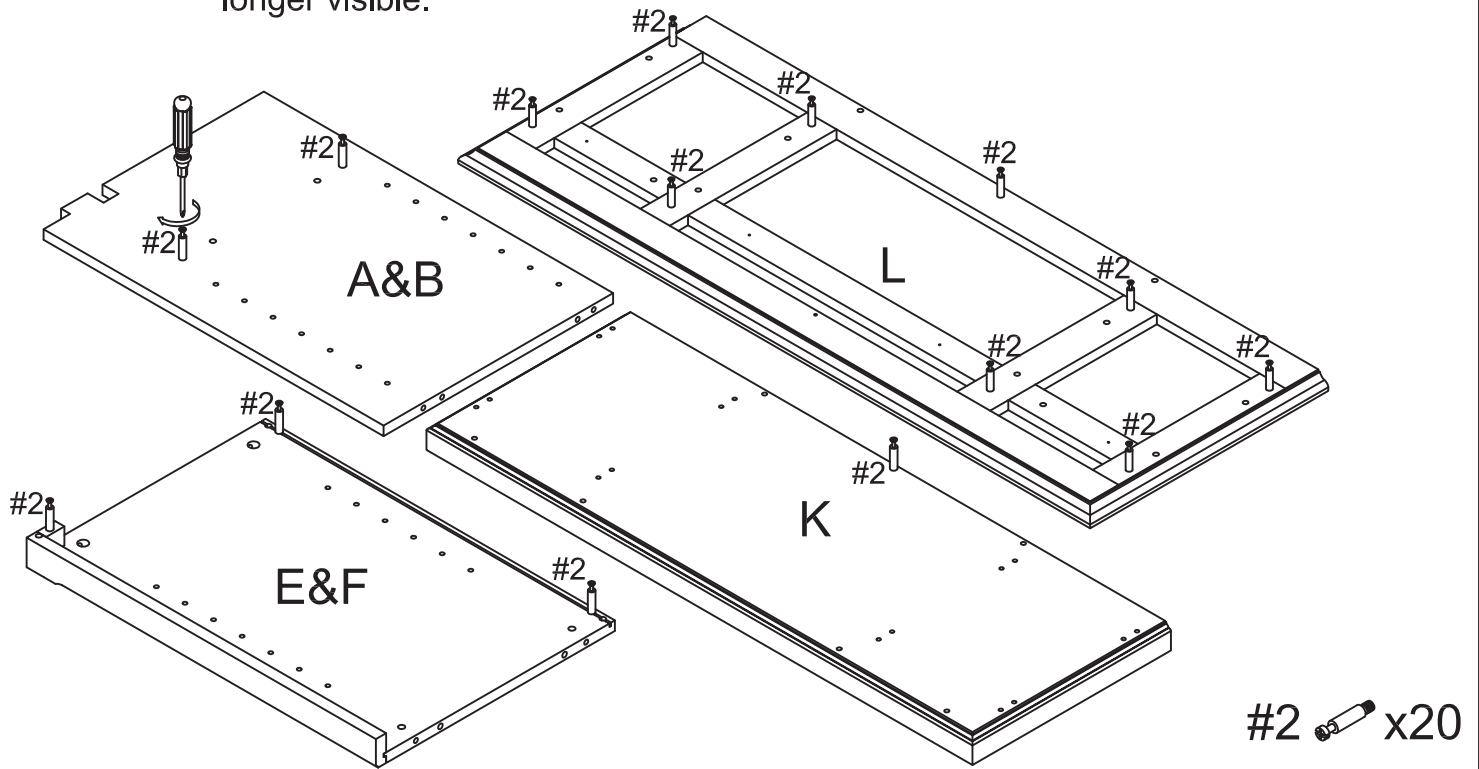

Step 2. Attach left vertical panel (part A) and right vertical panel (part B) to fixed shelf (part C) using cam locks (part #1) and wood dowels (part #3).

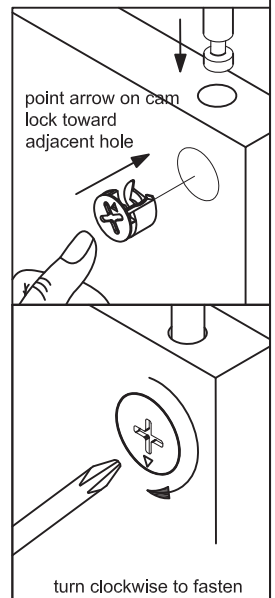
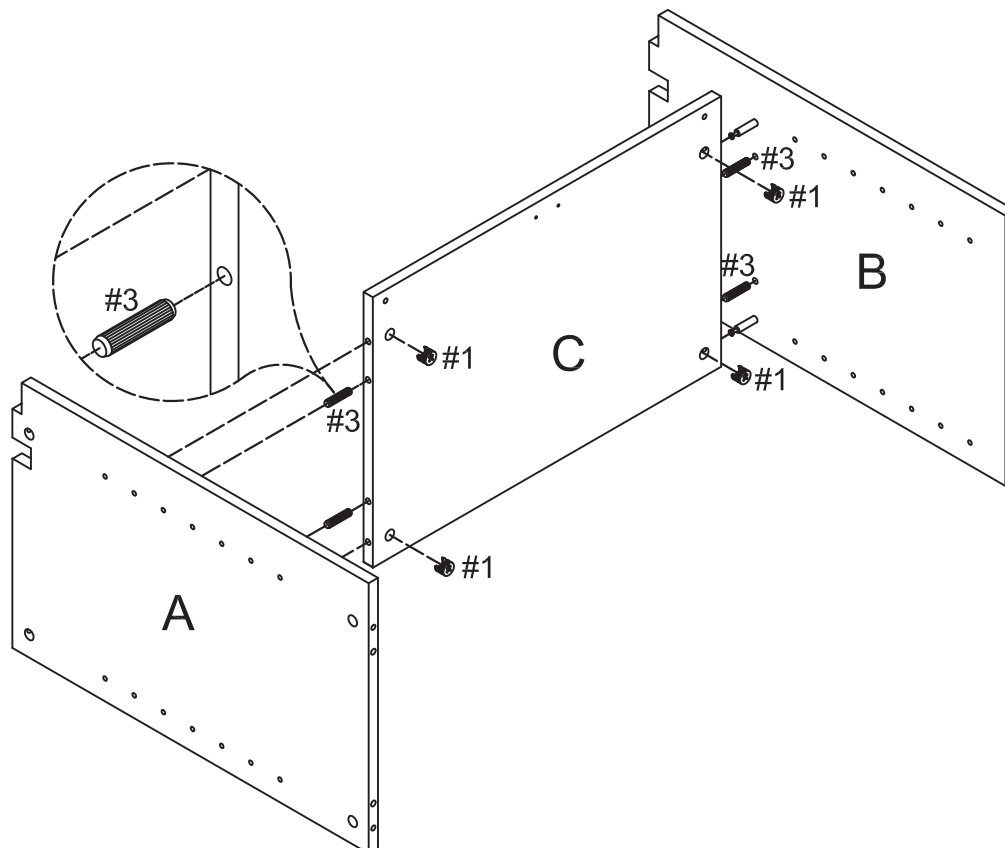

NOTE: Cam locks must rotate a full 180°. See pictured insert.

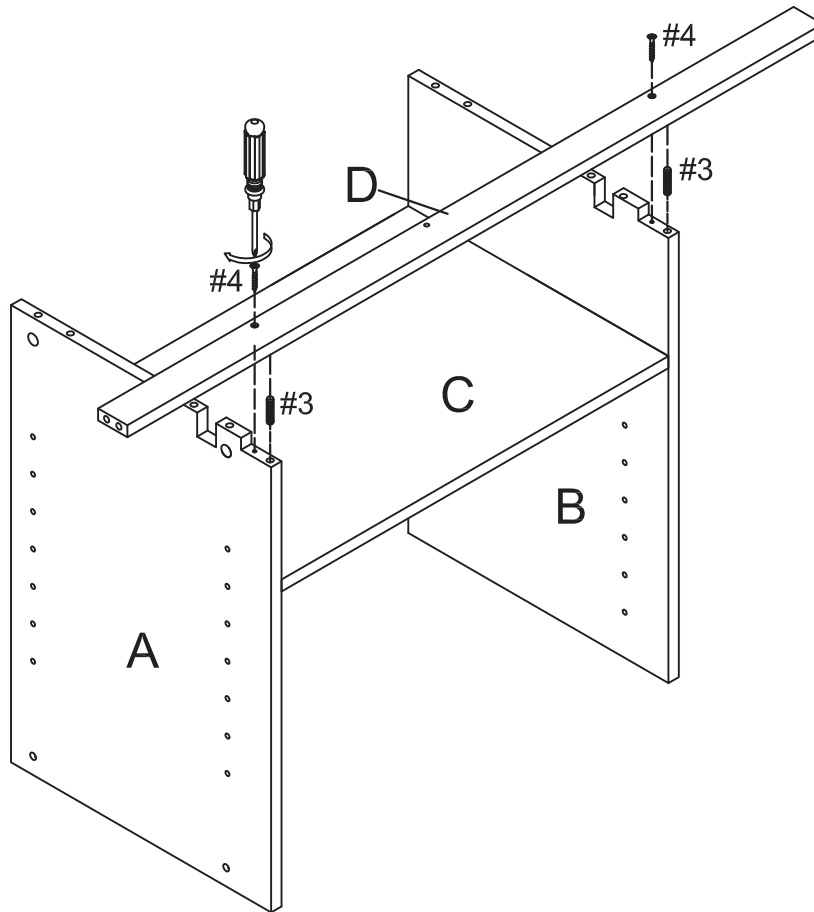

#1  x4
#3  x4

Step 3. Carefully turn unit upright. Attach front top rail (part D) to assembled unit (parts A & B) using wood dowels (part #3), screws (part #4) and phillips head screwdriver.





#3  x2
 #4  x2

Step 4. Carefully turn unit upside down. Attach left panel (part E) to front top rail (part D) using cam lock (part #1) and wood dowel (part #3).

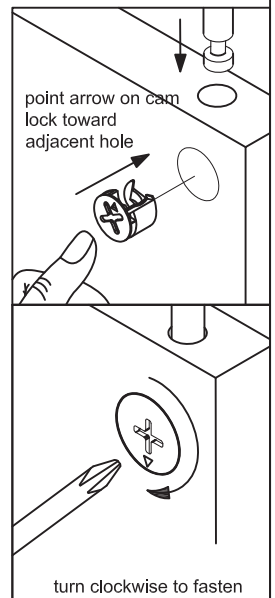
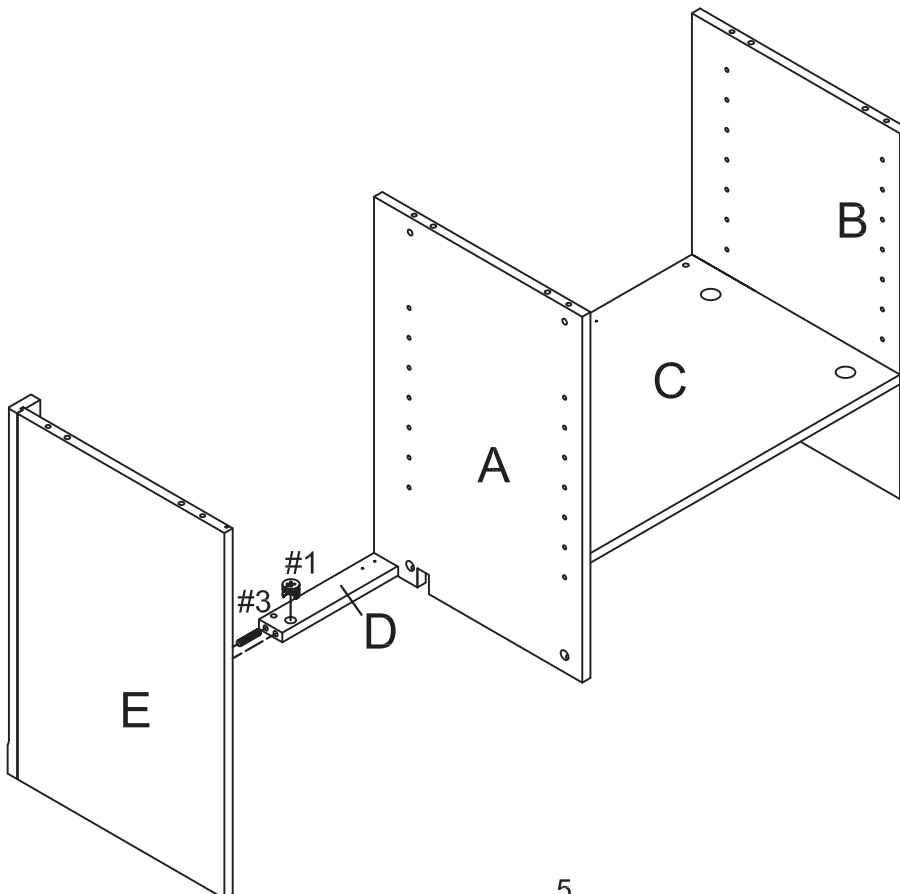
NOTE: Cam locks must rotate a full 180°. See pictured insert.





#1  x1
 #3  x1

Step 5. Attach back rail (part G) to left panel (part E) using cam lock (part #1) and wood dowel (part #3).

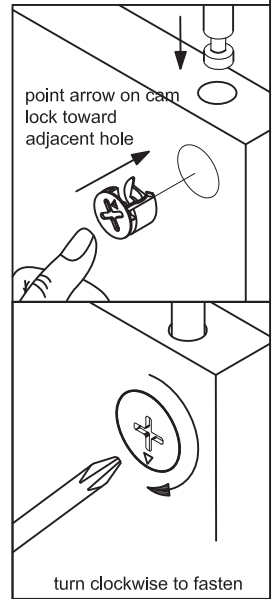
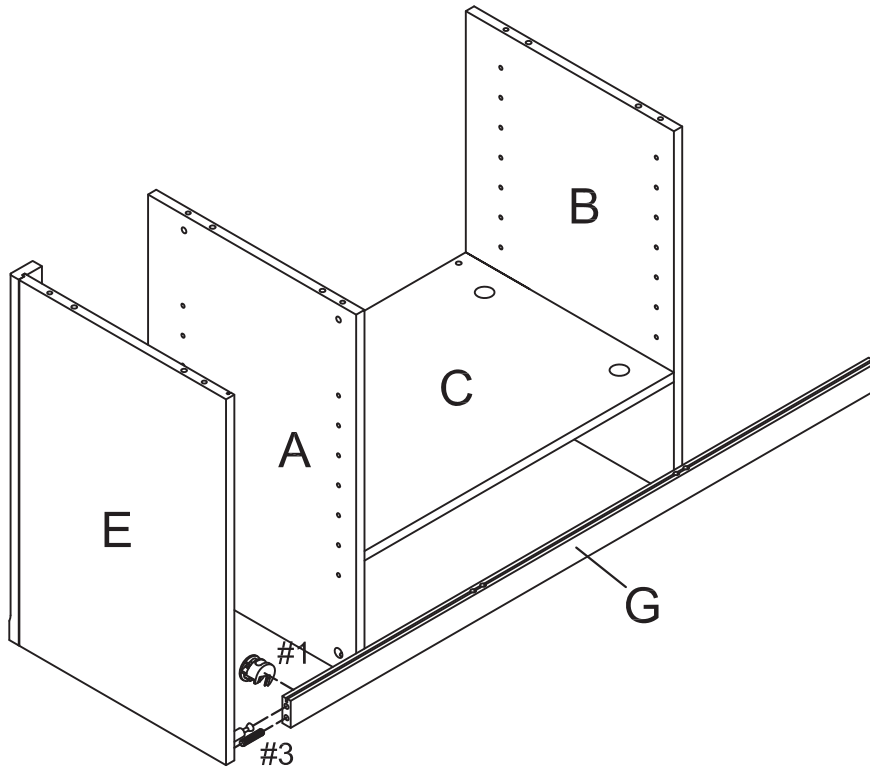
NOTE: Cam locks must rotate a full 180°. See pictured insert.



- #1  x1
- #3  x1

Step 6. Place back horizontal rails (part J) into back rail (part G) using wood dowels (part #3). Slide back panels (part H) and middle back panel (part I) into the grooves of back horizontal rails (part J) and back rail (part G). Attach back rail (part G) to left panel (part E) and back horizontal rails (part J) using cam lock (part #1) and wood dowels (part #3).

NOTE: Cam locks must rotate a full 180°. See pictured insert.

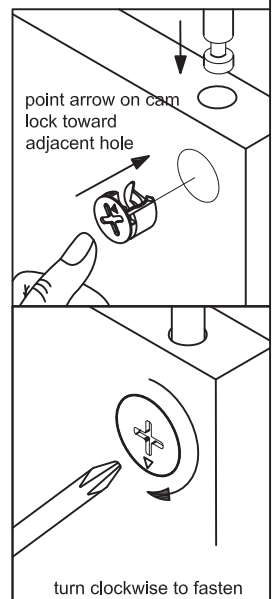
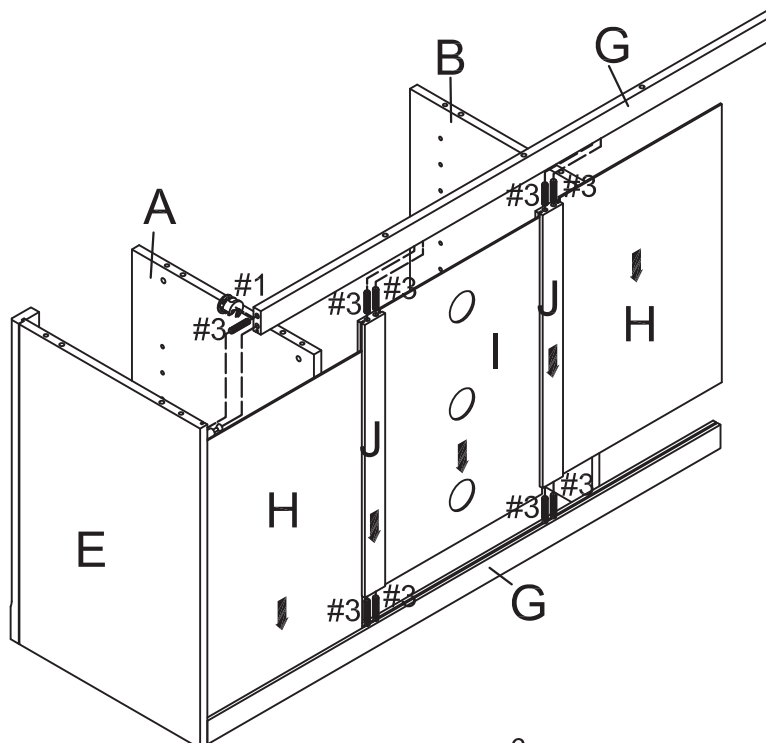



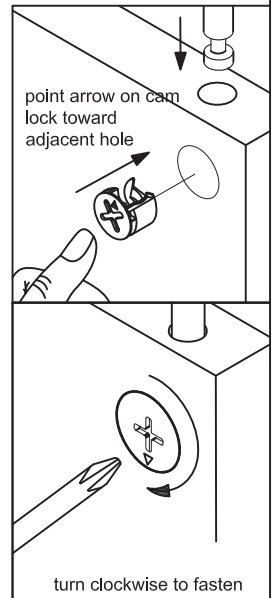
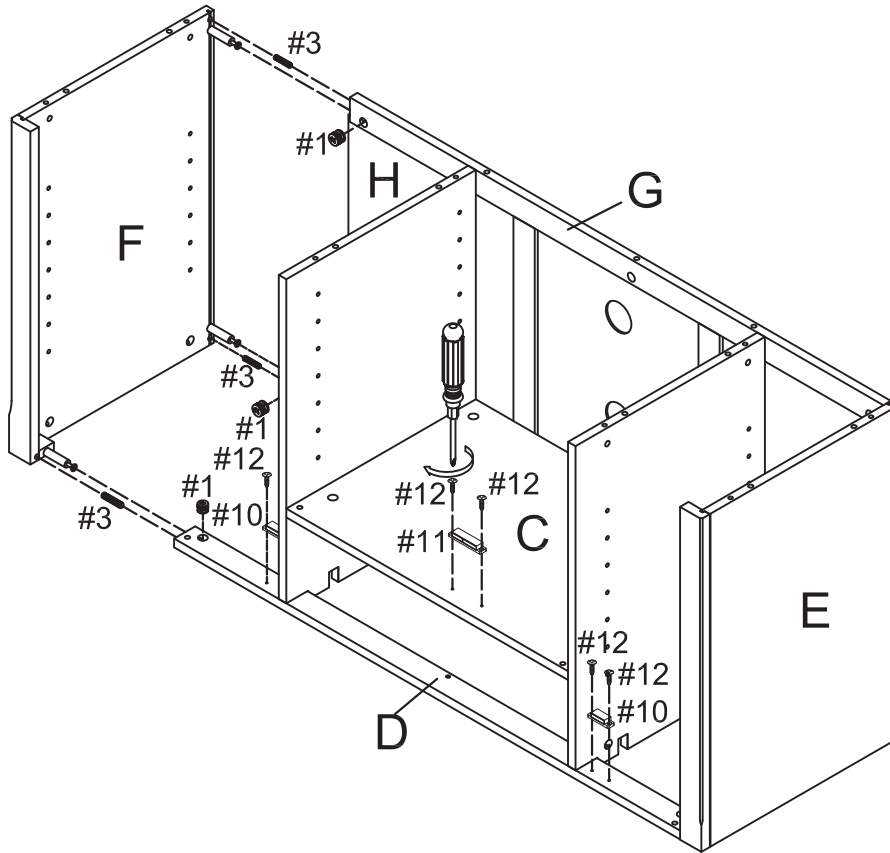

- #1  x1
- #3  x9

Step 7. Attach right panel (part F) to front top rail (part D) and back rails (part G) using cam locks (part #1) and wood dowels (part #3). Attach magnets (part #10) to front top rail (part D) and double magnet (part #11) to fixed shelf (part C) using round head screws (part #12) and phillips head screwdriver.

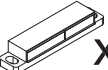

NOTE: Cam locks must rotate a full 180°. See pictured insert.

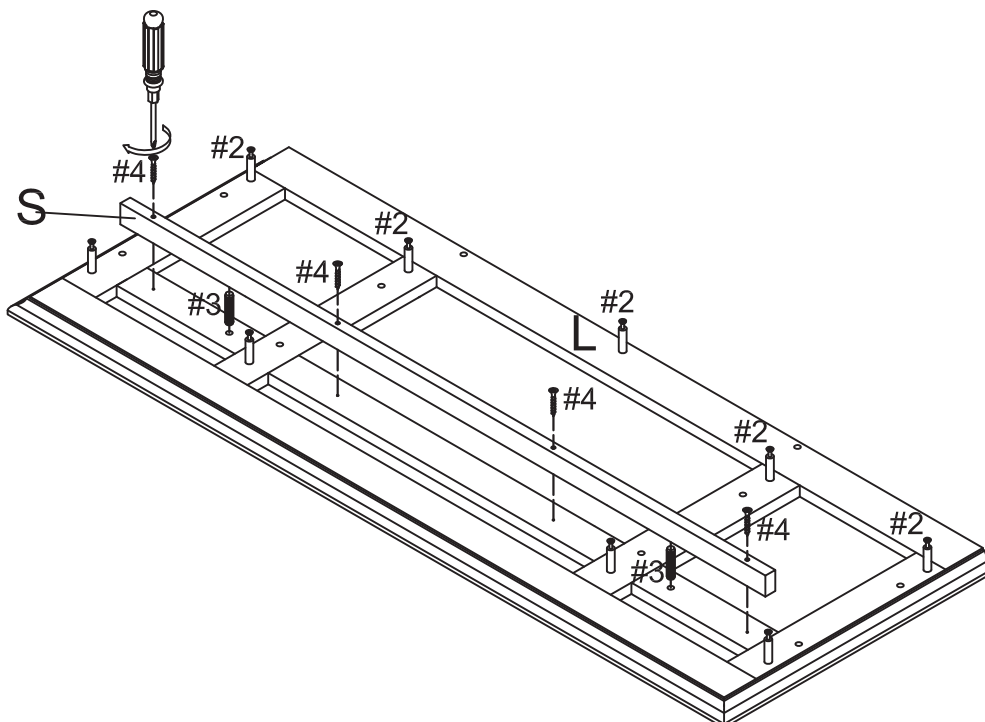

- #1  x3
- #3  x3
- #10  x2
- #11  x1
- #12  x6

Step 8. Attach support rail (part S) to top panel (part L) using wood dowels (part #3), screws (part #4) and phillips head screwdriver.





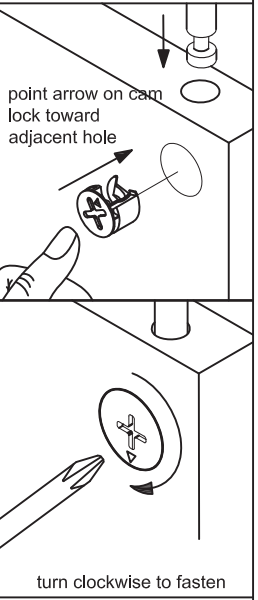
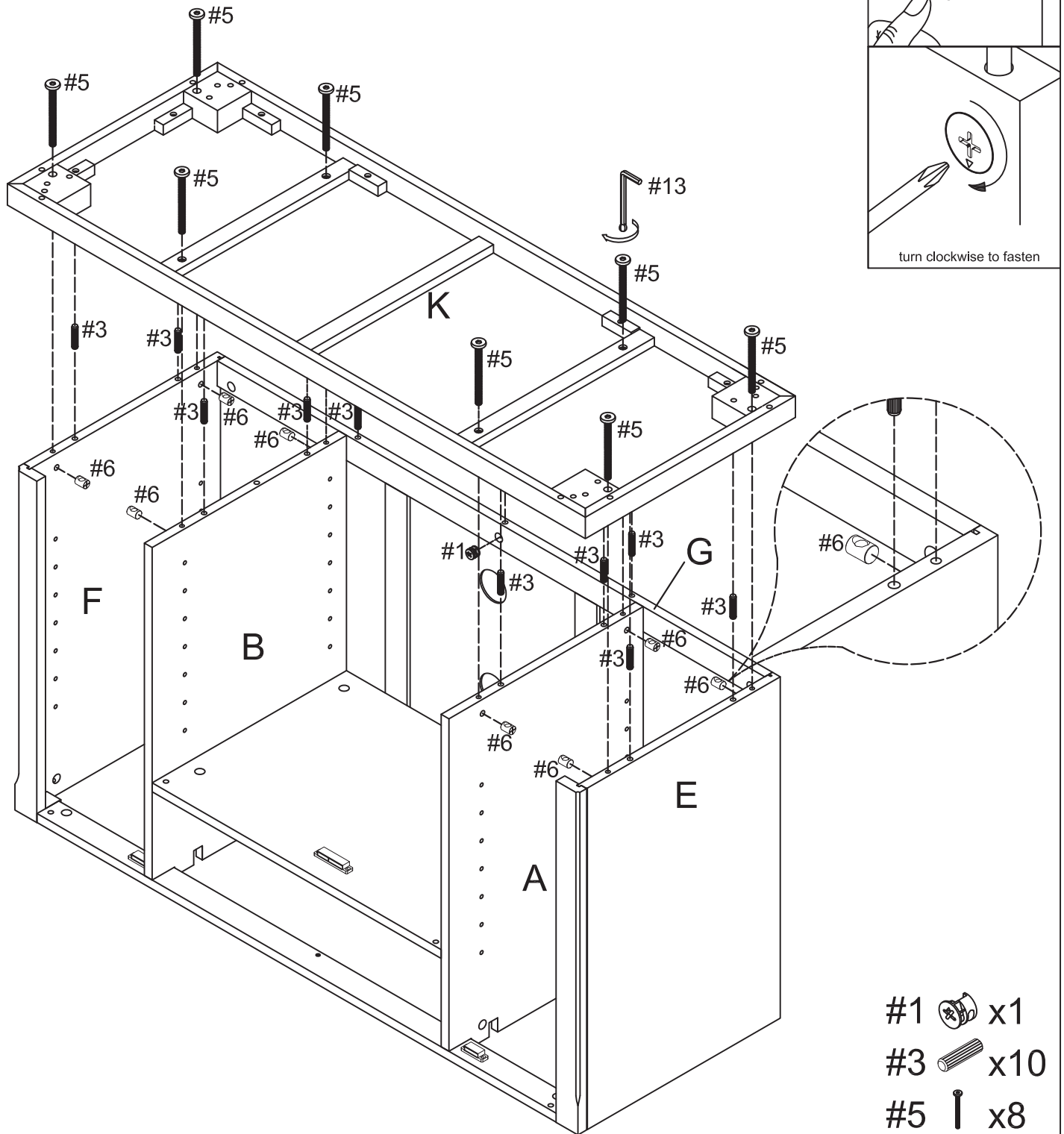

- #3  x2
- #4  x4

Step 9. Attach bottom panel (part K) to assembled unit (parts A, B, E, F & G) using cam lock (part #1), wood dowels (part #3), hex socket head bolts (part #5), barrel nuts (part #6) and allen wrench (part #13). Attach legs using instruction manual and hardware included inside leg packaging.

NOTE: Cam locks must rotate a full 180°. See pictured insert.





- #1  x1
- #3  x10
- #5  x8
- #6  x8
- #13  x1

Step 10. Carefully turn unit upright. Attach top panel (part L) to assembled unit (parts A, B, D, E, F & G) using cam locks (part #1), wood dowels (part #3), screw (part #4) and phillips head screwdriver.

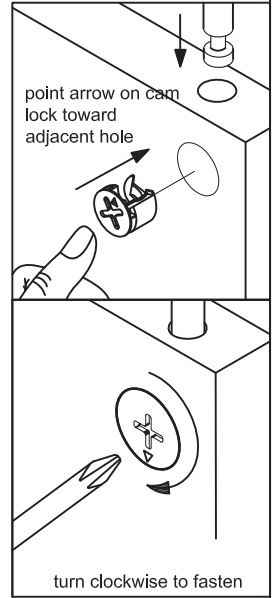
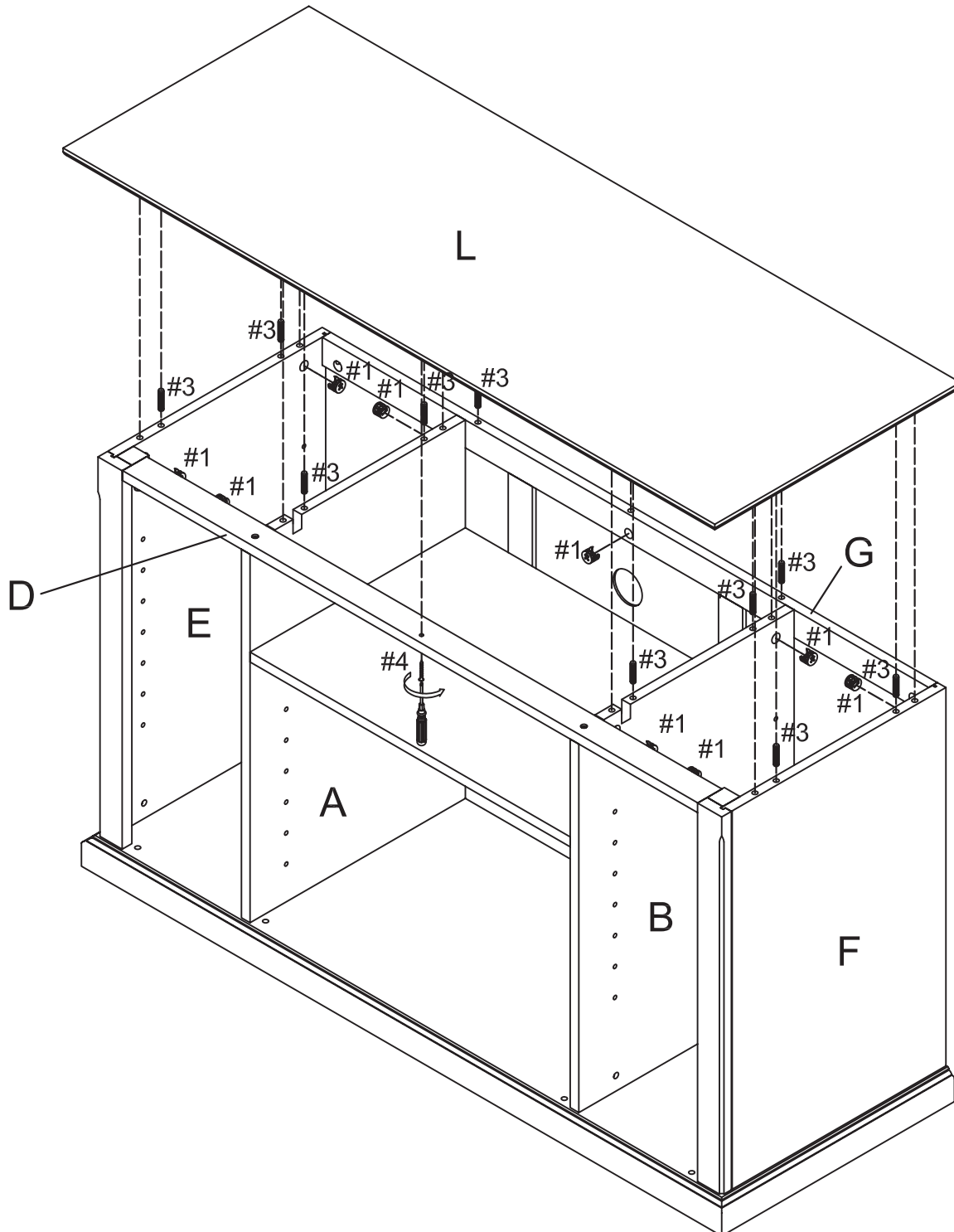
NOTE: Cam locks must rotate a full 180°. See pictured insert.





- #1  x9
- #3  x10
- #4  x1

Step 11. Attach knobs (part #8) to left door panel (part M), right door panel (part N), left middle door panel (part O) and right middle door panel (part P) using round head bolts (part #9) and phillips head screwdriver. Attach left door panel (part M), right door panel (part N), left middle door panel (part O) and right middle door panel (part P) by placing bottom pin hinge (pre-installed in door) in the pre-drilled hole of bottom panel (part K). Then depress the top spring-loaded pin hinge so it can be placed in the pre-drilled hole of fixed shelf (part C) and top panel (part L).

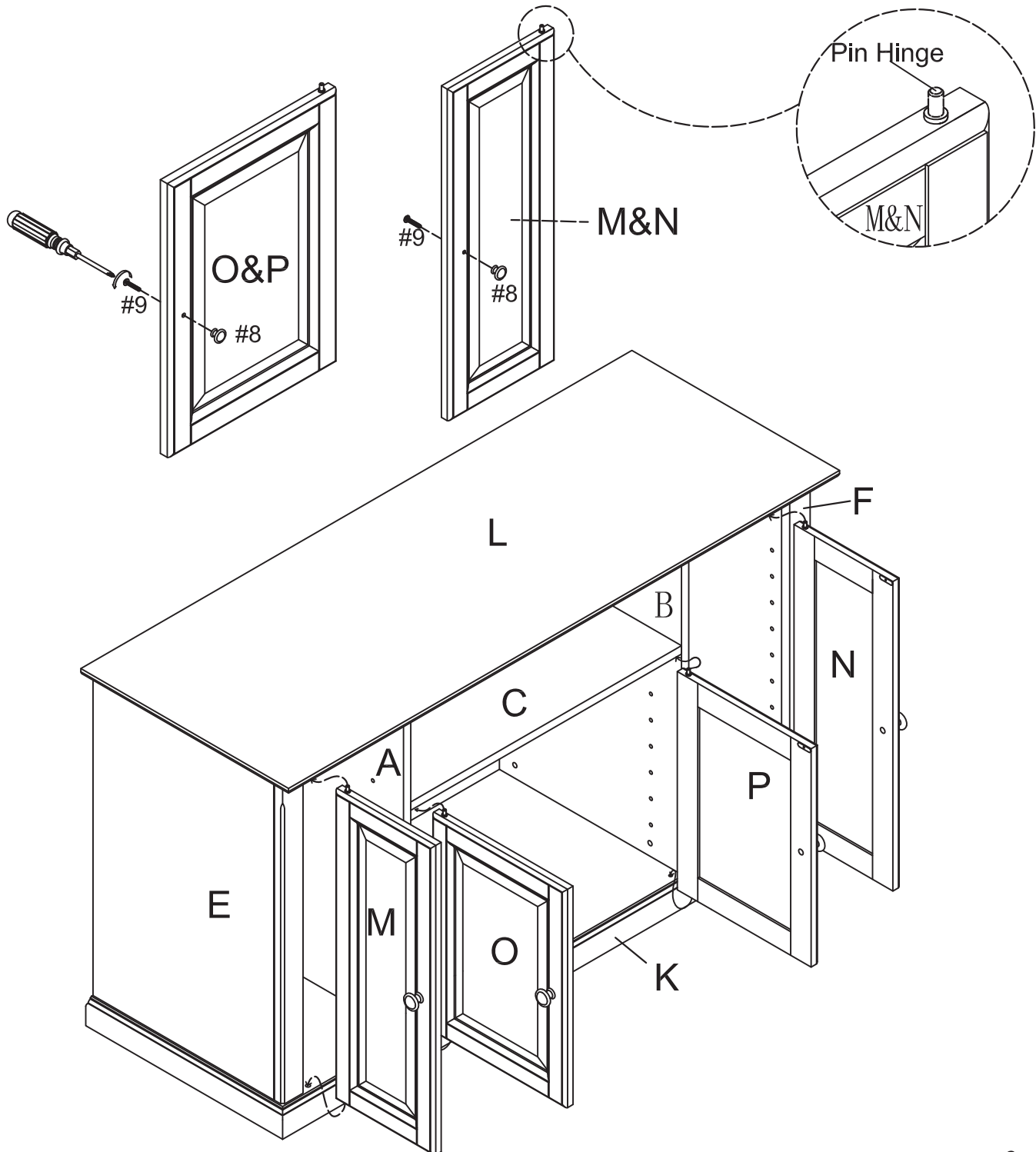



NOTE: Be sure top and bottom pin hinges are fully extended to secure doors in place.

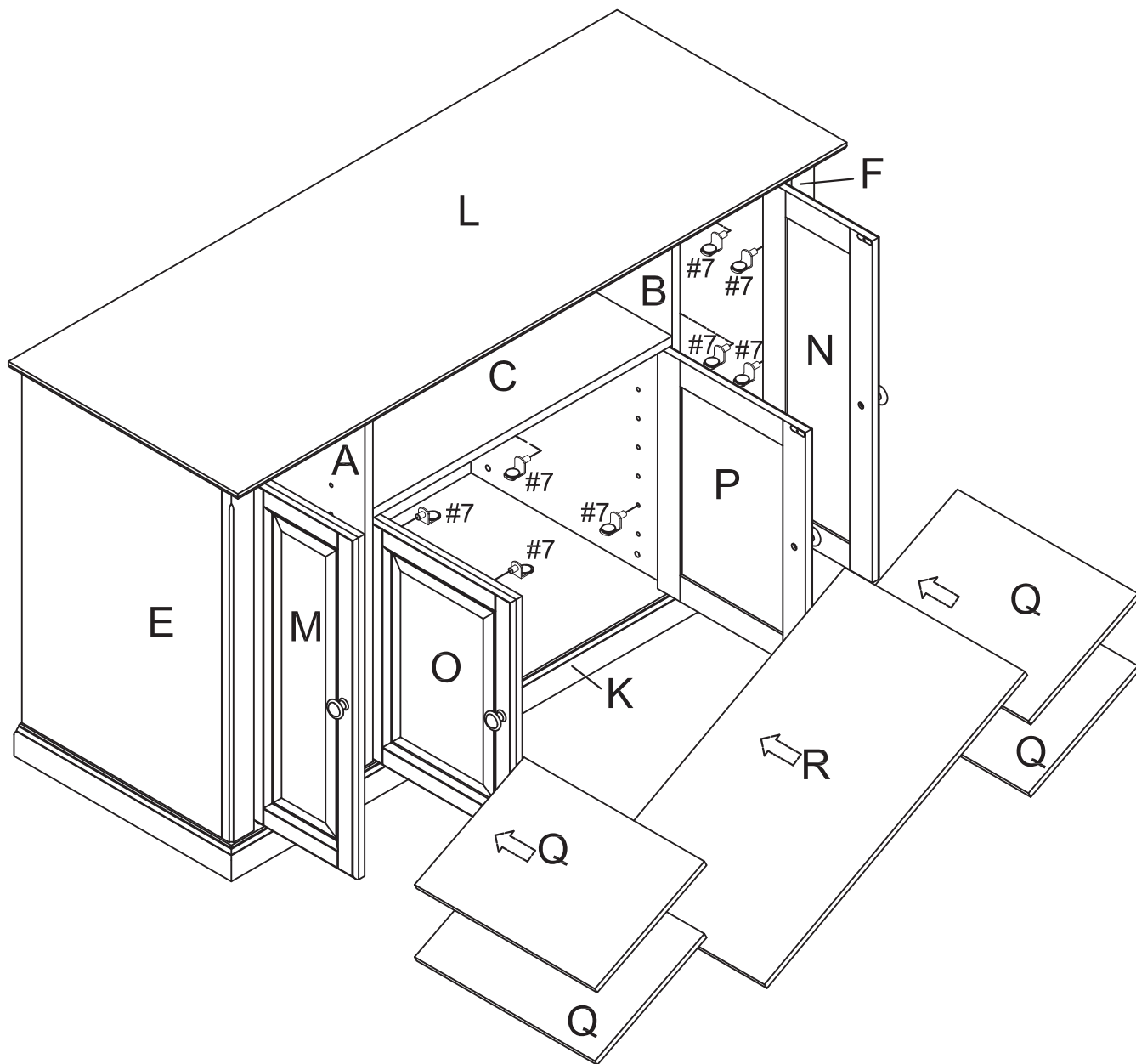

- #8  x4
- #9  x4

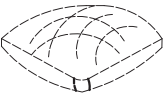
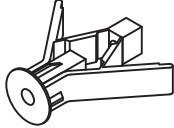
Step 12. Place shelf holders (part #7) into desired position and then slide adjustable shelves (part Q) and middle adjustable shelf (part R) into place.

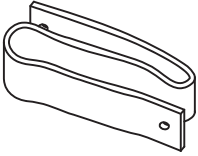

#14	A	B	C	D	E
			 D8*3/4"	 D8*1-1/2"	
Safety Strap Kit 1 SET	Wall Anchor 1 PC	Washer 2 PCS	Short Screw 1 PC	Long Screw 1 PC	Safety Wall Strap 1 PC

SAFETY WALL STRAP INSTALLATION

Note: It is highly recommended to install this safety strap kit to prevent tipping, damage and/or injury.

1. Insert short screw (C) through washer (B) and safety wall strap (E) and attach to back of top panel (part L) using phillips head screwdriver.

2. Drill a 11/32" hole where you want to secure the unit. The drilled hole will be at the same height as the hole in back of top panel (part L) where safety wall strap (E) is attached. Tap wall anchor (A) into the hole.

3. Insert long screw (D) through washer (B) and safety wall strap (E) into wall anchor (A) using phillips head screwdriver.

Note: This item is not intended for clothing storage use.

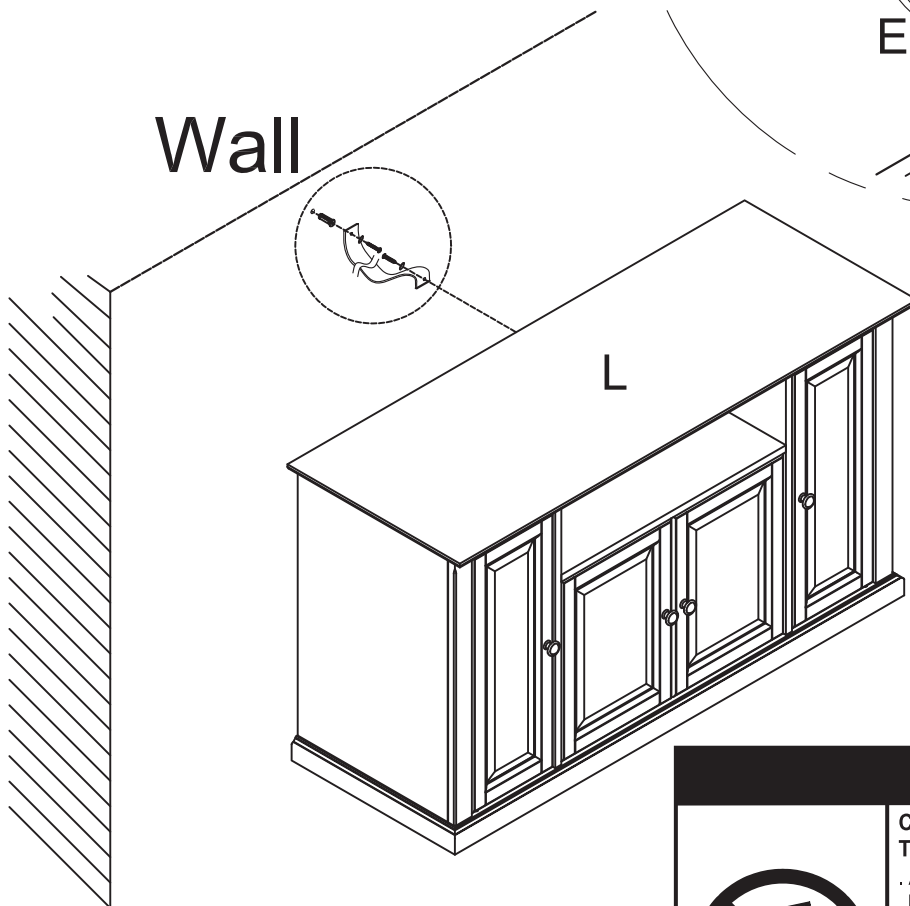
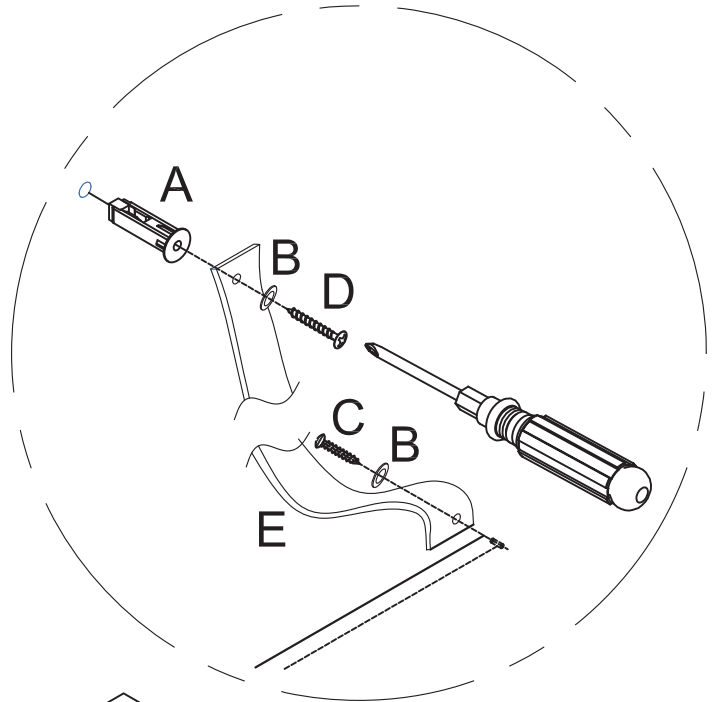

▲ WARNING



Children have died from furniture tipover. To reduce the risk of furniture tipover:

- ALWAYS install tipover restraint provided.
- For use with televisions weighing 50lbs(23kg) or less. Use with heavier televisions may result in instability causing tip-over resulting in death or serious injury.
- NEVER allow children to stand, climb or hang on drawers, doors, or shelves.
- NEVER open more than one drawer at a time.
- Place heaviest items in the lowest drawers.

This is a permanent label. Do not remove!